

# Kelly Tillage System

## Operating Instruction Manual

Register within 2 months of purchasing the machine to receive an additional 12 months warranty.

Find the registration information on page 3

Revision Q - April 2021

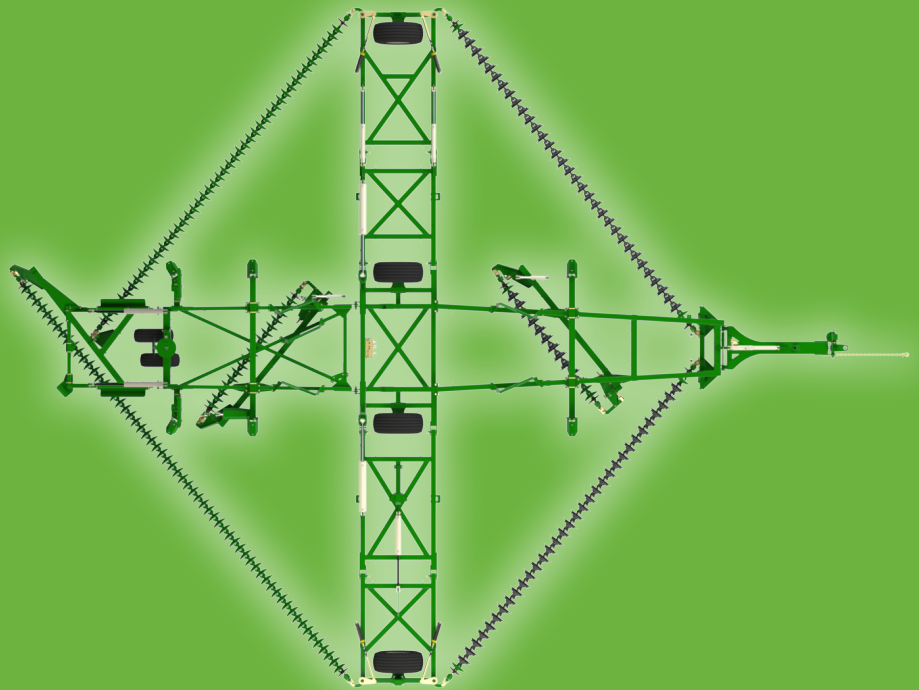

Kelly Tillage  
PO Box 100  
Booleroo Centre SA 5482  
Australia

Phone: + 61 8 8667 2253  
Email: [sales@kellytillage.com](mailto:sales@kellytillage.com)  
Website: [www.kellytillage.com](http://www.kellytillage.com)

# Kelly Tillage Owner's Record

Keep in manual & retain for your own record

## WARRANTY INFORMATION

### KELLY DIAMOND HARROW

Kelly Tillage guarantees its products against faulty workmanship and materials. Should any defects arise, Kelly will arrange at its discretion for the replacement or repair of defective parts for a period of 12 months from the date of purchase.

Disc Chain, Prickle Chain and swivel units are considered to be wear parts and it is reasonable to expect over time that these parts may need to be replaced. Kelly Engineering does however guarantee the swivel units for a period of 12 months or 10 000 acres (4000 Ha), whichever occurs first. Furthermore, Kelly Engineering guarantees the useful working life of the Disc and Prickle Chains to be in excess of 2 years or 50 000 acres (20 000 Ha), whichever occurs first.

Kelly is not responsible for freight charges incurred.

This warranty excludes damage caused by misuse, mishandling in transit or normal wear and tear. All Kelly Tillage products should be maintained according to the maintenance section in the supplied manual. Any unauthorized modifications to the equipment may result in cancellation of warranty.

**To activate the warranty a product registration form must be lodged with the manufacturer.**

### How will Kelly use my information?

- The information that you provide will be used by Kelly Tillage to contact you with relevant information about our business, products and services.
- We will hold this information for as long as necessary, and may pass it on to our dealers and associates in the interests of providing you with personalised customer service.
- Your information is your property, and you retain the right to request access, transferral, rectification and erasure of it, as well as the right to withdraw consent to our use of it and the right to lodge a complaint with a Data Protection Authority (DPA).

## OWNER'S RECORD

### Purchaser/owner

Name: \_\_\_\_\_

Address: \_\_\_\_\_  
\_\_\_\_\_

Contact number: \_\_\_\_\_

Email address: \_\_\_\_\_

### Purchase details

Place of purchase: \_\_\_\_\_

Date of purchase: \_\_\_\_\_

Model purchased: \_\_\_\_\_

Serial number: \_\_\_\_\_

# Kelly Tillage Product Registration

Register within 2 months of purchasing the machine to receive an additional 12 months warranty

Please complete our online Product Registration form at <http://www.kellyengineering.com.au/machine-registration/> or send this page via email, fax or post to receive an additional 12 months warranty

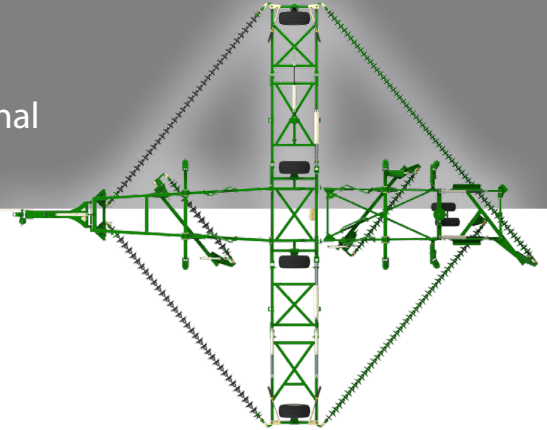

## Purchaser/ owner

Name \_\_\_\_\_

Address \_\_\_\_\_

Email address \_\_\_\_\_

Contact number \_\_\_\_\_

## Purchasing Details

Place of purchase \_\_\_\_\_

Date of purchase \_\_\_\_\_

Model purchase \_\_\_\_\_

Serial number \_\_\_\_\_

## Occupation

Farmer       Customer operator       Other \_\_\_\_\_

## What brought Kelly Engineering products to your attention ?

Field Day       Friend/ neighbor       Local Dealer       Social Media \_\_\_\_\_  
 Website       Family       Radio       Other \_\_\_\_\_  
 Demonstration \_\_\_\_\_       Magazine/Newspaper \_\_\_\_\_

## On a scale of 1 to 10 (10 being highest) how likely are you to recommend us to friends and family ?

1	2	3	4	5	6	7	8	9	10
---	---	---	---	---	---	---	---	---	----

If you scored 8 or below then what must we do to become a 10 in your eyes ?

---

---

If you scored 9 or above then please tell us why you gave us this score?

---

---

## Satisfaction with dealer/ agent

Was the machine pre-delivered satisfactorily ?  Yes  No \_\_\_\_\_

Were agents well informed about the product ?  Yes  No \_\_\_\_\_

Would you recommend the agent to other farmers ?  Yes  No \_\_\_\_\_

## Please return the registration & survey to :

### Fill out online

<http://www.kellytillage.com/machine-registration/>

### Email

[sales@kellytillage.com](mailto:sales@kellytillage.com)

### Fax

(Australia) +61 8 8667 2250

Internation dialling 011 618 8667 2250

### Mail to

Kelly Tillage

PO Box 100, Booleroo Centre SA 5482 Australia

# Thank you for choosing a Kelly Tillage product

We trust that you find the following manual clear and easy to follow. If you should require additional customer support or assistance, please do not hesitate to contact us.

Spare parts can be purchased, as required, through your local dealer or by contacting Kelly directly.

Kelly Tillage welcomes feedback. Should you have any difficulties that you wish to raise, suggestions for improvement or modifications that you feel would enhance our products we look forward to hearing from you.

## **Kelly Tillage**

**PO Box 100**

**Booleroo Centre SA 5482**

**Phone:** + 61 8 8667 2253

**Email:** [sales@kellytillage.com](mailto:sales@kellytillage.com)

**Website:** [www.kellytillage.com](http://www.kellytillage.com)

## **Spare Parts**

**Hood & Company Inc**

**Springfield MO**

**Phone:** 417 865 2100

**Email:** [hoodco@hoodco.com](mailto:hoodco@hoodco.com)



## **SAFETY FIRST**

Refer to section 1 in this manual on

## **SAFETY INFORMATION**

**Read all assembly instructions and study all photographs thoroughly before assembling the unit**

**Please note:**

Left and right is determined by standing behind the machine and looking to the front.

# Contents

	Page number
Warranty information	2
Section 1: Safety information	7
Section 2: Operation	16
Section 3: Specifications	27
Section 4: Hydraulic sequence valves	29

# **Section 1:**

## **Safety information**

Signal words

Safety guidelines

General operation

Transporting

Hydraulics

Maintenance and inspection

Safety decals and locations

## Safety information



### Signal Words

A signal word - **DANGER**, **WARNING**, or **CAUTION**, is used with the safety alert symbol.

When you see this symbol on your machine or in this manual, be alert to instructions involving your personal safety and the safety of others.

Failure to follow these instructions can result in injury or death.



**DANGER** - Indicates an immediate hazardous situation that, if not avoided, will result in **DEATH OR SERIOUS INJURY**.



**WARNING** - Indicates a potentially hazardous situation that, if not avoided, could result in **DEATH OR SERIOUS INJURY**.



**CAUTION** - Indicates a potentially hazardous situation that, if not avoided, may result in a **MINOR OR MODERATE INJURY**.

Carefully read all safety points in this manual and on your machine. Keep all safety decals in good condition and replace ones that have been worn or lost. Replacement decals are available by contacting your local dealer.

### Safety guidelines

- This equipment is dangerous to children and persons unfamiliar with its operation
- Do not allow persons to operate or assemble this unit until they have read this manual and have developed a thorough understanding of the safety precautions
- Do not attempt to operate this equipment under the influence of drugs or alcohol
- Review the safety instructions with all users annually.



# Safety information

## General operation

- Proceed cautiously under overhead powerlines and around power poles, as contact may result in the operator suffering a severe electrical shock
- Never allow anyone within the immediate area when operating machinery
- Stand clear when raising or lowering wings.

## Transporting

- Always travel at a safe speed. **NEVER EXCEED 15mph (25kmph).**
- Ensure your speed is low enough for an emergency stop to be safe and secure and reduce speed prior to turns
- Fit transport safety lock to front cylinder for highway use
- Ensure safety chain is attached correctly to the towing vehicle
- Please refer to your own state laws on the rules of transporting farm machinery on roads
- Ensure that disc or prickle chains are engaged in chain guides and supports. Discs or spikes should be clear of the ground
- It may be necessary to increase the spring tension on the brake assembly for road transport
- Castor wheel assembly may oscillate when towed above the recommended towing speed
- Be aware of the height, length and width of the machine. Beware of obstacles and overhead powerlines
- Check local laws and use approved accessory lighting, flags and necessary warning devices on the highway during both day and night time transporting. Various safety lights and devices are available from your dealer.

## Hydraulics

- **NEVER** remove hydraulic hoses or ends unless the machine is in either transport position or fully extended in working position. Relieve all hydraulic pressure before disconnecting hydraulic hoses and fittings
- Ensure all fittings and hoses are in good condition
- Do not search for high pressure hydraulic leaks without hand and face protection. A leak can penetrate the skin, thereby requiring immediate medical attention
- Double check that all is clear before operating hydraulics
- Maintain proper hydraulic fluid levels and pressure.

## Maintenance and inspection

- Good maintenance is your responsibility.
- Regular maintenance and inspection is imperative.

**Guidelines can be found on pages 23-24 in the Operation section**

**Attention:** Regularly checking the torque of the wheel nuts and hitch bolts is recommended. Refer to the bolt torque settings table for details.

# Safety information

## Safety decals - overview of decal placement

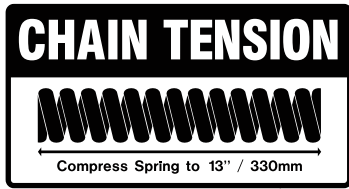

DO NOT FOLD WHEN CHAINS ARE PLUGGED WITH MUD	<b>HYDRAULIC FLOW</b> SET FLOW CONTROL TO 20%
<b>FOLDING</b>	<b>UNFOLDING</b>
<ol style="list-style-type: none"> <li>1. RAISE TAIL &amp; MODULES</li> <li>2. RAISE/FOLD WINGS</li> <li>3. RAISE FRONT</li> </ol>	<ol style="list-style-type: none"> <li>1. LOWER FRONT</li> <li>2. UNFOLD/ LOWER WINGS</li> <li>3. LOWER TAIL &amp; MODULES</li> </ol>

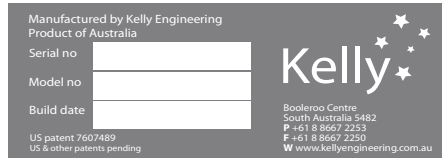

**INFLATE TIRE**  
**16.5L x 16.1**  
**to 250kpa/36psi**

**CHECK WHEEL NUTS**  
**AFTER FIRST .5 HRS**  
**AND AT REGULAR INTERVALS**

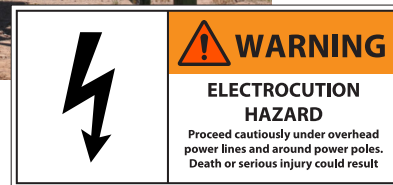

**Kelly *Diamond Harrow 45***



**If any safety decals are missing please contact your local dealer immediately and do not use the machine**

# Safety information

## Safety decals - individual placement

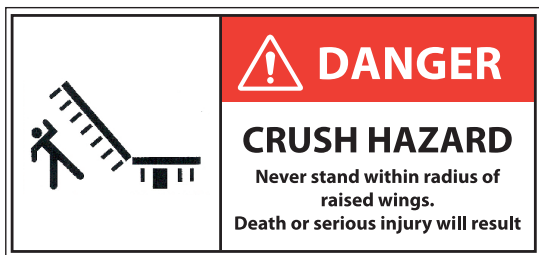

If any safety decals are missing please contact your local dealer immediately and do not use the machine

## Safety information

### Safety decals - individual placement



**BRAKE CALIPER.  
INCREASE SPRING  
PRESSURE FOR  
HIGHWAY USE.**



**If any safety decals are missing please contact your local dealer immediately and do not use the machine**

## Safety information

### Safety decals - individual placement

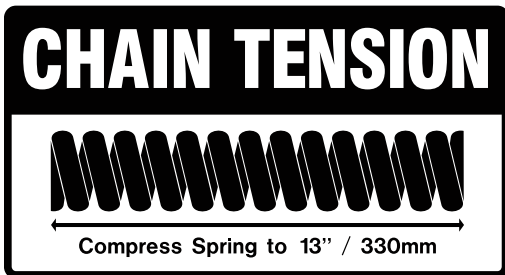

**CHECK WHEEL NUTS  
AFTER FIRST .5 HRS  
AND AT REGULAR INTERVALS**

**INFLATE TIRE  
16.5L x 16.1  
to 250kpa/36psi**



**If any safety decals are missing please contact your local dealer immediately and do not use the machine**

# Safety information

## Safety decals - individual placement

DO NOT FOLD WHEN CHAINS ARE PLUGGED WITH MUD	<b>HYDRAULIC FLOW</b> SET FLOW CONTROL TO 20%
<b>FOLDING</b>	<b>UNFOLDING</b>
<ol style="list-style-type: none"> <li>1. RAISE TAIL &amp; MODULES</li> <li>2. RAISE/FOLD WINGS</li> <li>3. RAISE FRONT</li> </ol>	<ol style="list-style-type: none"> <li>1. LOWER FRONT</li> <li>2. UNFOLD/ LOWER WINGS</li> <li>3. LOWER TAIL &amp; MODULES</li> </ol>

Manufactured by Kelly Engineering  
Product of Australia

Serial no

Model no

Build date

US patent 7607489  
US & other patents pending



Boileroo Centre  
South Australia 5482  
P +61 8 8667 2253  
F +61 8 8667 2250  
W www.kellyengineering.com.au



**WARNING**

**ELECTROCUTION HAZARD**

Proceed cautiously under overhead power lines and around power poles. Death or serious injury could result



**CAUTION**

**ESCAPING HIGH PRESSURE FLUID HAZARD**

Never check hydraulic system for leaks using hands or bare skin. Serious injury could occur. Seek medical help immediately

**CAUTION**

**MAXIMUM TOWING SPEED 15 MPH / 25 KPH**



**If any safety decals are missing please contact your local dealer immediately and do not use the machine**

# Safety information

## Safety decal - individual placement



Red reflective tape



Yellow reflective tape

### Red reflective tape - quantity : 4

Locate facing rearwards on each wing section  
50mm (2") from end of frame tube



### Yellow reflective tape - quantity: 12

Locate facing forwards on each wing section

Facing outward on outer face of outer wing

On under side of inner wing, to face out when folded

On diagonal face of main pull bearing support beam

On side face of rear tail, near rearmost corner

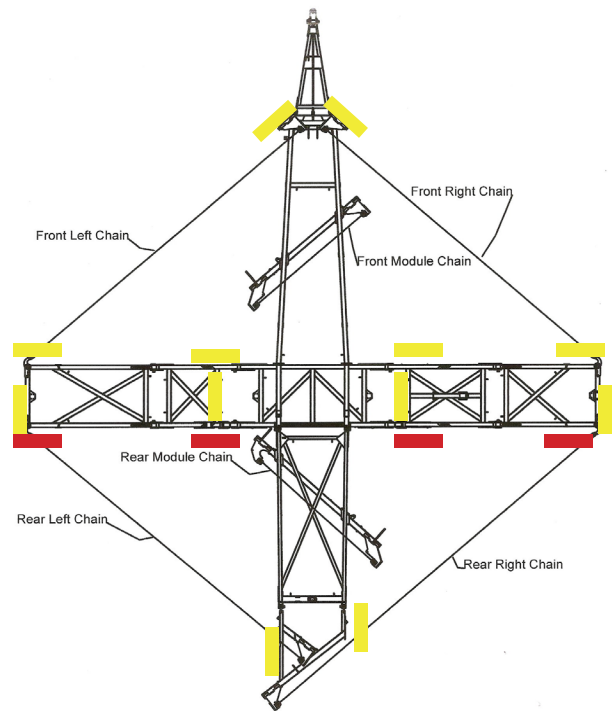

**If any safety decals are missing please contact your local dealer immediately and do not use the machine**

## **Section 2:** **Operation**

Before operation

Pre-operation checklist

Machine set up prior to operation

Basic operation

Chain mount arm height adjustment

Double T slot

Front A Frame height adjustment

Maintenance and inspection

Trouble shooting



# Operation

## Before operation

- Carefully study and understand this manual
- Do not wear loose fitting clothing that may catch in moving parts
- Always wear protective clothing and substantial shoes
- Be sure that there are no tools lying in or on the equipment
- Do not use the machine until you are sure that the area is clear, particularly of children or animals
- If this machine is being used in a dry area, or in the presence of combustibles, care should be taken to prevent fires and fire fighting equipment should be readily available
- Don't hurry the learning process or take the machine for granted. Ease into it and become familiar with your new equipment
- Familiarize yourself and other operators with the machine's operation before using.

## Pre-operation checklist

### Check

1	All bolts and nuts are tightened to the correct torque values
2	Split pins are in place
3	Stickers and warning signs are in place
4	Hydraulic fittings are tight
5	Wheel nuts are tight
6	Chains are adjusted so that there is still travel in the adjustors and chains are tight
7	Fold machine to ensure chains engage chain hangers

## Machine set up prior to operating



Unfold machine.

Extend lift cylinders until the float pins are centered in their slots.

(To allow wing oscillation in uneven terrain).

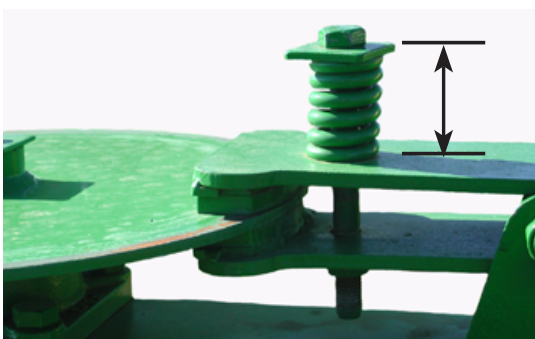

Set brake tension on castor wheels to suit ground conditions.

Compress spring to approx 2"- 2.25" (50-63mm).

(It is usually not necessary to constantly adjust the spring tension. A median setting that accommodates both field and highway use is practical. Make further adjustment if castor wheels oscillate during highway use).

# Operation

## Basic Operation

### Unfolding:

1. Walk around and inspect the machine.
  - a. Check that chains are not hooked on framework
  - b. Check swivel bolts are in place and not broken
  - c. Check th at height adjusting chains have not fallen out of their slotted plates during transport.
  - d. Ensure front lift cylinder depth stops are fully engaged on cylinder shaft.
2. Lower front A frame to working height.
3. Unfold wings holding the hydraulic lever until both the main center cylinder pins have centered in their slots. (If chain pulls tight during unfold, stop and inspect if chain is hooked)
4. Lower rear tail by holding hydraulic lever until tail and modules are completely lowered to working position.
5. Walk around and check that all chain links are straight and that working height of all swivels is correct for field conditions. Adjust if necessary.
6. Move off with all chains in working position. If necessary it is acceptable to raise front A pull to transport height. This will lift the front chains off the ground and reduce the load on the tractor. Lower the front A pull once moving satisfactorily.

### Folding:

1. Lower the front A frame to working height. (This is important to ensure that all chains locate correctly in their transport rests).
2. Raise the Rear Tail and modules by holding the hydraulic lever until they come to a complete stop.
3. Fold the wings. They should move as follows; main center cylinders will retract, one or both, until the wings stand vertically. The left outer wing then the right outer wing will fold down.
4. Raise front A frame to transport height.
5. Walk around and check that chains have located correctly in transport rests.  
**(30' only, close wing transport lock valves).**

## Setting for correct chain tension

### Wings

Use the spanner supplied. Loosen the lock nut adjacent to the tensioner assembly body. Turn the tension bolt clockwise to compress the coil spring. Correct tension is achieved when spring retains its set length when operator rolls the chain fore and aft on the ground. Retighten the lock nut.

See table below

### Spring Compression Length

Model	inches	mm
40	12.4	330

When less than 4" (100mm) of thread remains visible on the adjuster bolt then a link must be removed from the chain

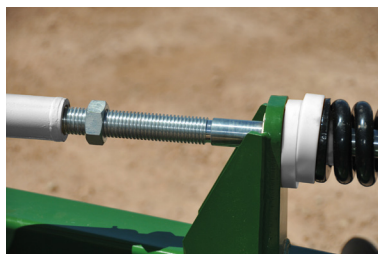

# Operation

## Modules

Loosen the lock nut on the draw bolt.

Tighten the adjusting nut clockwise until the outer face of the spring retaining washer is flush with the body of the module tensioning unit.

Retighten the lock nut.

If more than 8" (200mm) of thread is exposed then a link should be removed to maintain correct adjustment.



## Importance of chain tension

### Operational

It is imperative that the correct adjustment be maintained. Only through correct adjustment can a smooth and level finish be achieved in field working.

Loose chains lead to :

- Uneven performance across the width of the machine
- Uneven weed control
- Unsatisfactory incorporation
- Ineffective levelling
- Accelerated or premature chain wear
- Chains failing to engage with transport locators when folded
- Machine damage when folding or unfolding
- Uneven field surface with ridges and furrows being created. The leading 1/3rd of a loose chain is much more aggressive than the trailing 1/3rd and the center. This will mean that middle of the machine's front pair of chains will aggressively move soil outwards. The machine's rear pair of chains, if loose, have their aggressive 1/3rd near the wing extremity. It follows then that as the front discs push soil outwards, the least aggressive portion of the rear chain follows them and does not balance the soil movement. This is exacerbated at the wings, effectively creating a broad ridge about halfway out each wing. It won't be evident in one pass, but is possible if care is not taken over time.

**A correctly adjusted machine will not cause this phenomenon.**

## Operation

### Wear

Correct chain tension will ensure that the entire length of discs will roll as one. This minimises the movement between each link. If a chain is not adjusted and runs loose, each link acts as a universal joint as the curved chain rolls along. The wear rate between each link is greatly accelerated and can lead to premature failure. The chain should not wear out before the discs are worn down. ONLY POOR ADJUSTMENT CAUSES THIS.

- The chain may sag not more than 12" (300mm) when working
- At rest there should be less than 4" (100mm) of sag in the chain.



Indicator line shows acceptable curvature when operating

# Operation

## Settings for correct working height

To adjust the swivel height at the wings, relocate one of the polyurethane spacers either above or below the fixed mounting tube.

## Adjustment

1	Loosen chain tension completely
2	Undo 2 x M10 bolts from corresponding spacer set and take the two halves off of the drop leg tube
3	Replace it in the selected position after raising or lowering the drop leg
4	Reinstall the M10 bolts and re-tension the chain

It is possible to install all spacers either above or below the mounting tube giving a maximum of 4" (100mm) of adjustment.

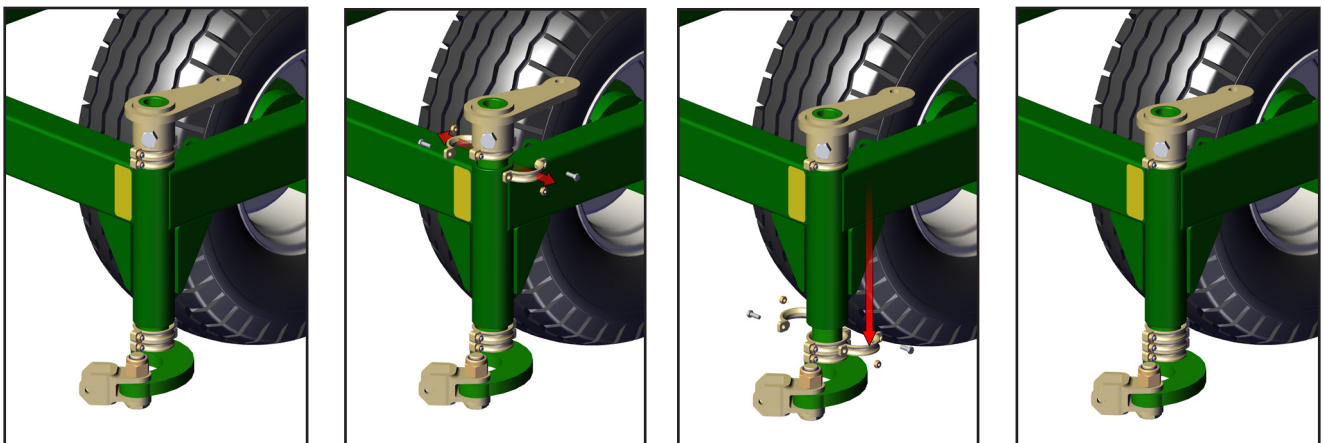

## Chain mount arm height adjustment

Use the tractor hydraulics to raise the module or chain mount plate that requires adjustment. Position a suitable block or stand to support the arm. Using the tractor hydraulics, lower the machine until the height adjusting chains are loose. Remove spring retaining clip. Slide chain links through slot in lifting arm, turn links 90 degrees for fine adjustment. Install retaining clip. Remove stand.



## Operation

### Double T slot

Use tractor hydraulics to raise the module chain or chain mount plate that requires adjustment.

Position a suitable block or stand to support the arm.

Using the tractor hydraulics, lower the machine until the height adjusting chains are loose.

Remove spring retaining clip.

Slide chain up to the top of the slot in lifting arm to pass the chain through the cross at top of plate and slide chain back down to the bottom when the desired position is reached.

To achieve "1 link" of adjustment lift chain to the top of the slot pass 1 link through the slot and rotate 90 degrees to allow the next link in the adjusting chain to be lower into the same slot.

To achieve "½ link" of adjustment lift the chain to the top of the slot and slide chain horizontally and lower the same link into the second slot, this will raise or lower the chain mount plate by half a link depending on which slot the chain started in.

Any excess chain can be fed back through the second slot

Install retaining clip

Remove stand.



### Front A frame height adjustment



## Operation

It is important to spend some time setting up the swivel heights to achieve a good result. It is critical in achieving a level finish that the swivel heights are set correctly.

It is possible with correct adjustment to achieve a level finish in most situations by manipulating the front and rear heights of each chain.

The leading disc on each chain, if set too low has the capability of pushing up a ridge of soil that the following chains may not level out. This can occur at the front of each module, at the front of the rear chains (widest point) and at the front of the machine (either side of center).

The trailing disc on each chain, if set too low has the capability of leaving a furrow that may not be filled by other chains. Look for this at the rear of each module chain, on the wings at the rear of the front chains and at the very rear of the machine near the center line.

There is enough overlap built into the machine to ensure that it is possible to raise the front of all of the chains just clear of the ground and still achieve a full cut.

The optimum setting may vary depending on soil cover. In heavy stubble and unworked ground it is possible to set the swivels low to the ground. In light stubble or loose soil it is best to raise the leading discs so that the chains 'feather in' to the soil.

The main pull and rear tail should both be horizontal. ie parallel to the ground. Fine adjustments should be made using the adjustor chains at each bearing mount plate.

Once the main pull is set correctly apply whoa stop spacers (supplied) to the rod of the front A pull cylinder. This sets the draw bar height correctly for your tractor.

It is important to note that lowering the swivels will not cause the discs to dig deeper or more aggressively. It will result in premature wear of swivel hardware and the first two chain links. It will also cause ridges and furrows to appear.

Digging effectiveness is a result of soil conditions and disc chain construction. The weight, shape, angle and spacing of the discs are the factors which influence efficacy. On hard dry soils it is unrealistic to expect the discs to dig fully or evenly. They will however still perform well for residue breakdown and seed stimulation.



**To prevent injury never lubricate or service Chain Harrow while it is moving (folding up or down or in working motion)**

# Operation

## Maintenance and inspection

### Good maintenance is your responsibility

- Before working on machine, ensure all moving parts have stopped
- Always use a safety support and block the wheels
- Use extreme caution when making adjustments
- Replace shields and guards after servicing and before moving
- After servicing, make sure all tools, parts and service equipment are removed
- Where replacement parts are necessary for periodic maintenance and servicing, genuine factory parts must be used. Kelly Engineering will not claim responsibility for use of unapproved parts and other damages as a result of their use and will not be liable for injury or warranty if equipment has been altered in any way
- A fire extinguisher and first aid kit should be kept readily available while performing

## Intervals

### 1. After FIRST use

- Visual check after first usage. Check for loose or missing hardware, oil leaks
- Retighten wheel nuts.

### 2. Daily

- Check chain tension
- Visual check for loose or missing hardware, especially chain/bearing bolts and pin retaining hardware
- Check for oil leaks or damaged hydraulic hoses.

Immediately after stopping the machine, walk around and check the swivel units. A significant increase in temperature indicates a failing bearing. Replace with the spare swivel unit supplied and rebuild or replace the failed unit. Approximate operating temperature is 131 deg F (55 deg C). Failure is indicated at approx. 176 deg F (80 deg C).

### 3. After 25 hours of use

- Grease kingpin bearings on castor wheel assembly at rear of machine
- Grease wing tension assembly threads
- Grease wing hinge pins x 8
- Grease brake caliper pivot bush
- Grease center frame cylinder pins (cylinder knuckles).

### 4. End of season ready for storage

- Lubricate threads on the chain tensioners for out of season storage. The machine is designed so that all cylinders are retracted for storage
- Ideally cover chain swivels to prevent ingress of water during storage.



# Operation

## Maintenance and inspection

### 5. Pre-season. After storage

- Check chain tension
- Visual check for loose or missing hardware, especially chain/bearing bolts
- Check for oil leaks or damaged hydraulic hoses
- Check tire inflation pressures
- Grease all points
- Check chain swivels for free and smooth rotation.
- Check wheel nuts
- Check pivot pins and cylinder pins for wear
- Check and repack wheel bearings and hubs with grease.

### Trouble shooting

The majority of Chain Harrow operating problems can be traced to improper adjustment. This trouble shooting section may help you by suggesting a probable cause and a recommended solution.

Symptom	Problem	Solution
Wings bouncing	Wing tire pressure too low	Refer to page 16 for tire pressure specifications
	Operating speed is too fast for field conditions	Reduce speed
Back tires wearing	Castor wheel oscillation	Increase brake spring tension
	Possible king pin bearing failure	Check and replace bearing
	Wheel bearing failure	Check and repair bearing
	Flat tire	Check and repair
	Excessive brake pad wear	Replace brake pads
	Mud build up between wheels and on frame	Remove mud
	Stone jammed between wheels	Remove stone
Chain Links wearing	Chain too loose. Chain loops back when working.	Check length and adjust to correct tension. See pg 17-19
	Swivel set too close to ground.	Raise to correct height.
Difficulties in folding of the machine	Low tractor hydraulic pressure	Refer to local dealer
	Hydraulic flow too high	Set hydraulic flow to slow. 20% or 8gpm (30Lpm)

# Operation

## Trouble shooting

Symptom	Problem	Solution
	Sequence valve maladjusted	Refer to section 4 -Sequence valve adjustment.
Chain not rotating	Bearing failure in swivel unit	Check and replace
	Front chain swivels on machine too low	Lift front swivels using adjustors / front cylinder
	Foreign material fouling bearings	Clear foreign material from the chains, especially around bearings
Uneven tread wear on transport wheels	Tire pressure too low Excessive road speed	Inflate to correct pressure See table pg 27 Travel at prescribed speed
Chains not locating properly on chain hangers	Front too high when folding machine	Pull should be at working height when folding machine
	Folding chain up on uneven ground	Refold on flat even surface
	Chain out of adjustment - too slack	Adjust chain tension
Operation leaves central ridge behind machine	Front chain swivels are too low	Raise front swivel/s
Operation leaves central furrow behind machine	Rear chain swivels are too low	Raise rear swivels
Ridging on outside edge of machine	Leading end of corresponding rear chain is too low	Raise corresponding wing swivel
Furrow on outside edge	Rear of front chain set too low	Raise corresponding wing swivel
Ridge 5' (1.5m) either side of center line.	Leading disc on a module chain is set too low.	Raise the corresponding chain mount arm
Furrow 5' (1.5m) either side of center line.	Trailing disc on a module chain is set too low	Raise the corresponding chain mount arm



**Never attempt to fold for transport if the chain is clogged with weeds or mud as the extra weight may damage hydraulics or frame**

## **Section 3:** **Specifications**

Operating speeds

Tire pressure

Chain Harrow specifications

Bolt torque settings

# Specifications

## Operating speeds

Operating speeds for normal conditions	
Chain type	Speed
Prickle Chain	6-10 Mph / 10-16 kmph
Disc Mulch Chain	6-8 Mph / 10-12 kmph
Transport / towing on roads	15 Mph / 25 kmph

## Tire pressure

Tire size	Ply	PSI	KPA
16.5L x 16.1	14	36	250
H40 x 14.5-19	26	60	410
11L - 15	10	44	300
15.5/80/24	16	58	400
16.5/85/24	16	55	380
550/60/22.5	16	40	280
400/60/22.5	16	50	350
12.5/80/18	14	85	590
15.0/70/18	14	71	490

## Chain Harrow specifications

Model	20'/6m	9m	30'	12m	40'	Model 46	60CT	62HDX	80'
Working width	24'0"/7.3m	31'10"/9.7m	32'6"/9.9m	41'4"/12.6m	43'4"/13.2m	48'6"/14.8m	62'8"/19.1m	62'8"/19.1m	84'0"/25.6m
Transport width	7'10"/2.4m	7'10"/2.4m	11'6"/3.5m	9'10"/3.0m	11'6"/3.5m	12'9"/3.9m	17'1"/5.2m	16'5"/5.0m	24'11"/7.6m
Transport height	12'0"/3.6m	11'2"/3.4m	13'1"/4.0m	13'1"/4.0m	12'2"/3.7m	13'5"/4.1m	14'9"/4.5m	15'5"/4.7m	15'1"/4.6m
Transport length	34'1"/10.4m	39'4"/12.0m	40'8"/12.4m	47'11"/14.6m	52'6"/14.3m	56'1"/17.1m	72'2"/22.0m	73'10"/22.5m	93'6"/28.5m

## Bolt Torque Settings

Bolt Type	Wheel nut				U Bolt			Grade 8.8 Bolt					Grade 10.9 Bolt		Grade 8 Bolt
	M18	M20	1/2"	9/16"	M10	M12	M16	M10	M12	M16	M20	M24	M20	M24	1" UNF
<b>Ft lb</b>	255	265	90	100	22	36	55	32	48	140	190	270	300	350	849
<b>Nm</b>	345	360	125	140	30	50	75	44	65	190	260	370	406	475	1151

[1] When fitting a wheel & tire to a hub, do the wheel nuts up in rotation to the correct tension. To achieve this choose a wheel nut & tighten, then go clockwise to the next wheel nut & tighten & so on until all wheel nuts are tight. Then repeat the procedure to check that all nuts are tight. Do not use impact tools to tighten wheel nuts. For a guide to the correct tension of the wheel nuts please use the appropriate tension for your size wheel nuts from the Bolt Torque Settings table.

Torque values are for dry threads and surfaces however it is permissible to apply a small amount of anti corrosive oil to the threads.

## **Section 4:**

# **Hydraulic sequence valves**

**For models 9m / 30 / 12m / 40 / 46 / 60CT / 62HDX / 80**

Sequence valve overview

Sequence valve manifold - flow chart

Explanation of valve function

Factory setting Table for sequence valve manifolds

HF 111938-16, V12 split circuit

Model 30

Trouble shooting

# Hydraulic sequence valves

## Sequence valve overview

### **Hydraulic flow setting on tractor must be set to 20% - Max flow 8 gallons per minute**

The sequencing valve manifold incorporated in Kelly Engineering Diamond Series Chain Harrow provides simple and reliable operation. The manifold is pressure sensitive; once set right it will give many years of trouble free service. If operating conditions change it may be necessary to make adjustments to various valves. This section should help you trouble shoot any problems and make the appropriate adjustments. At the beginning of the section are the factory settings, should you need to start again.

Like all hydraulic components the main enemy is contamination. Care should be taken at all times to prevent contamination entering the hydraulic circuit. Self cleaning line filters are fitted to the tractor hoses on the pressure section of the manifold.

The valve manifold controls the folding and unfolding of the Diamond Chain Harrow. One or two pairs of hoses connect the valve manifold to the tractor. One pair operates the tail and module circuit. The other pair fold and unfold the wings. Only newer models have the second pair for the tail. A third pair of hoses operate the tongue cylinder.

Oil is directed to the first stage of a fold or unfold sequence. When the cylinders reach the end of their stroke and pressure mounts, a sequence valve is triggered allowing oil to flow to the next stage. The sequence valves automatically reset themselves when system pressure allows.

The valve manifold incorporates over/center (O/C) or counterbalance valves as a safety measure. These O/C valves prevent the tail or wings from falling in the event that one of the tractor hoses should fail, manage smooth folding and hold the wings straight out in their working position. The newest type manifolds incorporate pressure control valves to prevent damage to the machine in case things go wrong when folding.

**Note. The valve manifold has a maximum flow capacity of 8 Gallons (US) per minute (30Lpm).**

**For the purposes of this instruction view all directions as though standing behind the machine looking forward.**

# Hydraulic sequence valves

## Sequence valve manifold - flow chart

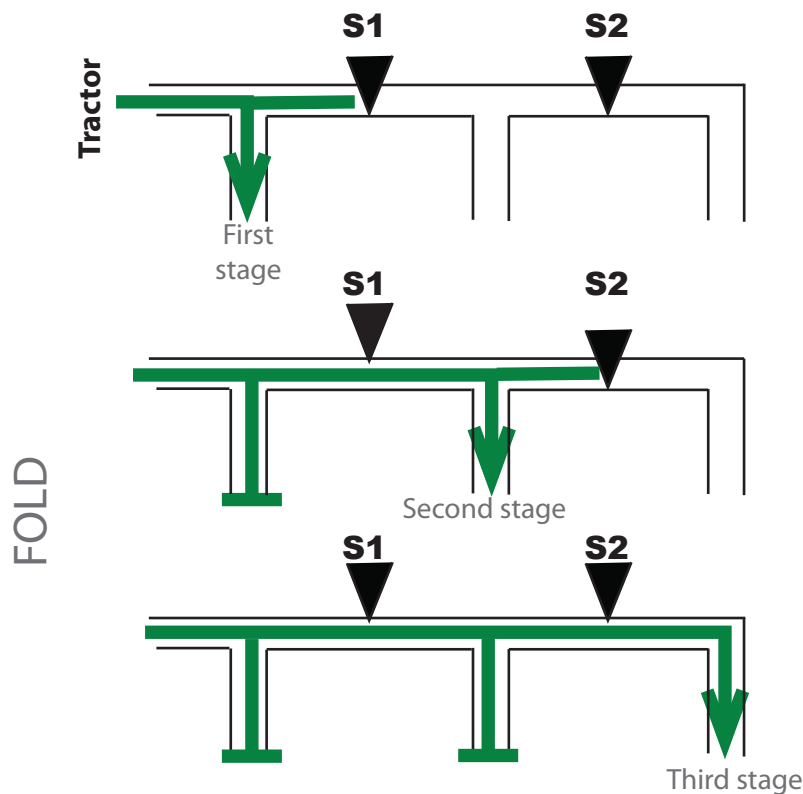

**Step 1 - Raise tail and modules fully**

**Step 2 - Raise wings until folded**

**Stage 1**

S1 closed S2 closed.

Oil is flowing to main wing cylinders

**Stage 2**

S1 open, S2 closed.

Oil is flowing to left outer wing

**Stage 3**

S1 & S2 open. Oil is flowing to right outer wing

**Step 3 - Raise front tongue assembly fully**

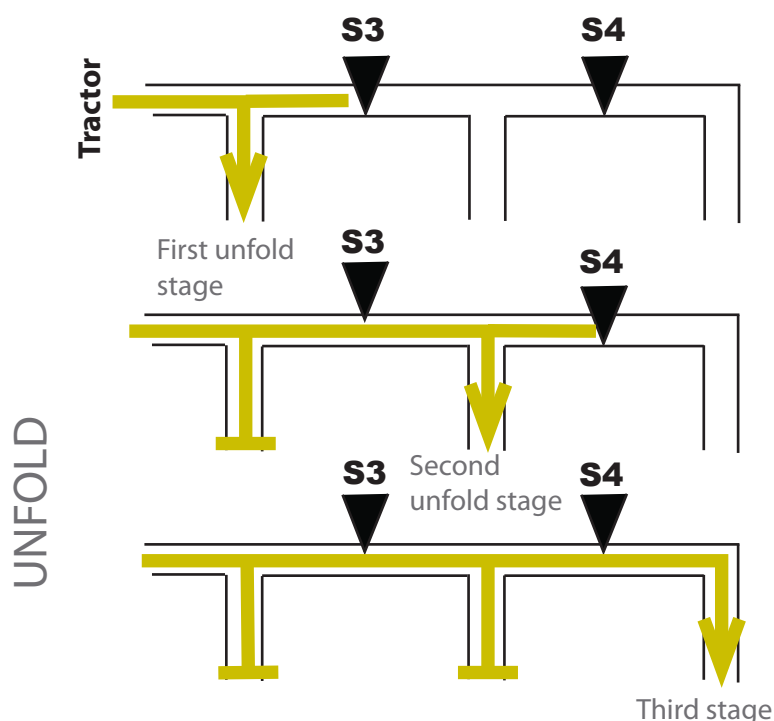

**Step 1 - Lower front tongue assembly to working position**

**Step 2 - Unfold wings fully**

**Stage 1**

S3 closed. Oil is flowing to right outer wing

**Stage 2**

S3 open, S4 closed.

Oil is flowing to left outer wing

**Stage 3**

S3 open S4 open.

Oil is flowing to main wings, modules and tail

**Step 3 - Lower tail and modules fully.**

# Hydraulic sequence valves

## Explanation of valve function

### Main wing fold circuit

- E Flow controller to increase or decrease oil flow for extending (unfolding) wing fold cylinders
- R Flow controller to increase or decrease oil flow for retracting (folding) wing fold cylinders
- S1 Sequence valve that remains closed until main cylinders are closed (inner wings fold vertical). It then opens to allow left outer wing to fold
- S2 Sequence valve that remains closed until left outer wing is folded. Then opens to allow right outer wing to fold
- S3 Sequence valve that remains closed until right outer wing unfolds to vertical. It then opens to allow left outer wing to unfold
- S4 Sequence valve that remains closed until left outer wing unfolds to vertical. It then opens to allow main wing cylinders to extend and unfold both main wings to working position
- L1 Over/center valve that holds main wings in position if tractor hose fails. Prevents wings falling
- L3 Over/center valve that holds the right wings out straight when working
- L4 Over/center valve that holds the left wings out straight when working
- C1 Check valve for return oil from right outer wing unfold. Can seem like S2 problem
- C2 Check valve for return oil from left outer wing fold. Can seem like S3 problem
- C3 Check valve for return oil from left outer wing unfold. Can seem like S1 problem
- C4 C5 Check valve for return oil from main wing cylinder folding. Can seem like S4 problem

**Note - Check valves are located on back face of some manifolds. Not all valves are installed in all manifold models.**

### Tail and module circuit

- L2 Over/center valve that holds tail in raised or partially raised position
- L5 Over/center valve that holds the two center module chains up for transport & storage.



## Hydraulic sequence valves

Factory setting: Table for V12 sequence valve manifolds.

Valve number	Factory setting - turns counter clockwise from bottoming out	To increase pressure - turn :	To decrease pressure - turn :
S1	2 1/2	Clockwise	Counter clockwise
S2	3 1/8	Clockwise	Counter clockwise
S3	3 1/8	Clockwise	Counter clockwise
S4	2 3/4	Clockwise	Counter clockwise
L1	3.5	Clockwise	Counter clockwise
L2	2.25	Clockwise	Counter clockwise
L3	3.5	Clockwise	Counter clockwise
L4	3.75	Clockwise	Counter clockwise
L5	3.5	Clockwise	Counter clockwise

Valve number	Factory setting - turns counter clockwise from bottoming out	To increase flow - turn :	To decrease flow - turn :
E	2.5	Counter clockwise increases flow. One turn is 4 gpm	Clockwise reduces flow. One turn is 4 gpm
R	2.5	Counter clockwise increases flow. One turn is 4 gpm	Clockwise reduces flow. One turn is 4 gpm

These settings are true or a very good starting point for all valves regardless of manifold model. Note that not all valves are installed in older models' manifolds.

# Hydraulic sequence valves

## HF111938-16, V12 - split circuit

Kelly Part Number 0802-691033

**Adjusting Sequence Valve (HF111938-16, V12 - split circuit) for the 9m, 40, 12m, 45, Model 46, 60CT, 62HDX & 80' Kelly Diamond Harrow**

Valve block model # is on the left end of the valve block, toward the front.  
Internal filters located on left and right ends and underside of valve block.

.

Make sure tail hoses are on TR1 and TE1.

- 1) Slow down the flow of the tractor hydraulics to 20% or about 8-10gpm.
- 2) It may be necessary to remove extra weight such as mud buildup on discs.

**Identify if the problem is on the folding or unfolding sequence.**

**Unfolding = extend and Folding = retract**

### Folding problems

This valve block is split into two circuits. One set of hoses controls the raising and lowering of the tail and modules independent from the wing fold. Raise the tail first. Then loosen the jam nut on the sequence valve cartridges S1 and S2. Increase valve pressure settings by screwing in S1 and S2 (clockwise) until they bottom out. Activate the folding circuit with the tractor control valve. The main wings will raise/fold. The left and right outer wings will not fold. Screw out S1 (counter clockwise) until the left outer wing folds then give it another ½ turn. Next, the right outer wing will not fold. Screw out S2 (counter clockwise) until the right outer wing folds then give it another ½ turn.

### Unfolding problems

Before unfolding, check to make sure the discs are not caught on the M brackets or other carrier arms. Loosen the jam nut on the sequence valve cartridges S3 and S4. Screw in S3 and S4 (clockwise) until they bottom out. Now activate the unfolding circuit with the tractor control valve. The right outer wing will unfold and nothing else will move. Screw out S3 (counter clockwise) until the left outer wing unfolds then give it another ½ turn. Next, the main wings will not unfold. Screw out S4 (counter clockwise) until the main wings unfold, then give it another ½ turn. Since the valve block is split into two parts, you will need to now activate the tail circuit to lower the tail and modules.

When multiple tractors are to be used, set valves to the tractor that has the lowest pressure (most times the oldest tractor).

If the above adjustments have been made and there are still problems, you may want to look at the other check valves and over/centre valves.

Bottom out the valves (clockwise) and then back out (counter clockwise).

## Hydraulic sequence valves

### Over/Center valves

L1 – 3.5 turns out; controls main wings from free fall

L2 – 2.25 turns out; controls tail, holds it up for storage and transport

L3 – 3.5 turns out; controls lock up on RH outer wing

L4 – 3.25 turns out; controls lock up on LH outer wing

L5 – 3.5 turns out; controls modules, holds them up for storage and transport

### Check valves

If a check valve is open due to contamination, the symptom will be as though the corresponding sequence valve is open.

C1 - is the check valve to bypass around S2 (right outer wing) on the folding circuit

C2 - is the check valve to bypass around S3 (left outer wing) on the unfolding circuit

C3 - is the check valve to bypass around S1 (left outer wing) on the folding circuit

C4 - is the check valve to bypass around S4 (main wing) on the unfolding circuit

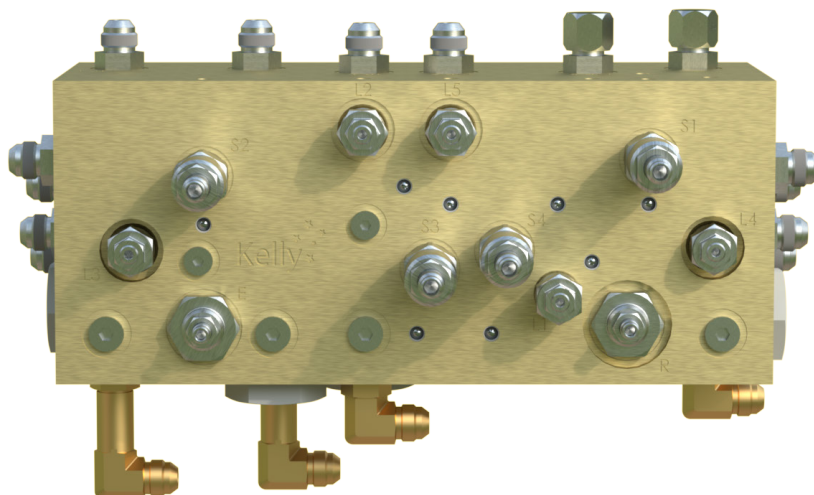

# Hydraulic sequence valves

## Model 30

### Sequence valve adjustment

If attempts have been made to adjust valves without the knowledge of proper valve operations and settings, it may be best to return to the factory settings.

Bottom out the valves (clockwise) and then back out (counter clockwise):

Left wing over/center (L O/C)	1 ¾ turns out
Right wing over/center (R O/C)	1 ¾ turns out
Tail over/center (T O/C1 & 2)	2 ¼ turns out

To further fine tune valve settings, do the following:

- 1) Slow down the flow of the tractor hydraulics to 20-25% or about 10gpm.
- 2) It may be necessary to remove extra weight such as mud buildup on discs.

Identify if the problem is on the folding or unfolding sequence.

### Folding issue

The tail and modules should come up first. If there is a plug in the S1 port, then move on to the unfolding instructions (see figure 1). If the valve block is equipped with a sequence cartridge in the S1 port (figure 2) then loosen the jam nut on the sequence valve cartridges. With a 5mm Allen wrench, screw in ST (clockwise) until it bottoms out. (S1 is only used to control the folding circuit while the T O/C over/center valve is used to control the tail while unfolding). Activate the folding circuit with the tractor control valve. The tail will raise/fold. The wings will not raise/fold. Screw out S1 (counter clockwise) until the wings start to fold then give it another ½ turn.

In newer models, Figure 3, the tail circuit is independent of the wings, ie there are two pairs of hoses connecting the valve body to the tractor remotes. The tail and module O/C valves hold those items in position, either fully or partially raised.

### Unfolding issue

The tail should go down last. If the tail does not go down last then loosen the jam nut on the T O/C over/center valve cartridges. Set this valve at or about 2 ¼ turns out. O/C valves are turned clockwise to decrease pressure and counter clockwise to increase pressure. This is backwards to how it seems like it should be.

On newer models it doesn't matter in which order the tail or modules come down, so long as this is after the wings are unfolded fully via the wing fold circuit. If tail or modules creep down during storage, increase the pressure (screw the valve counter clockwise 1/2 turn).

# Hydraulic sequence valves

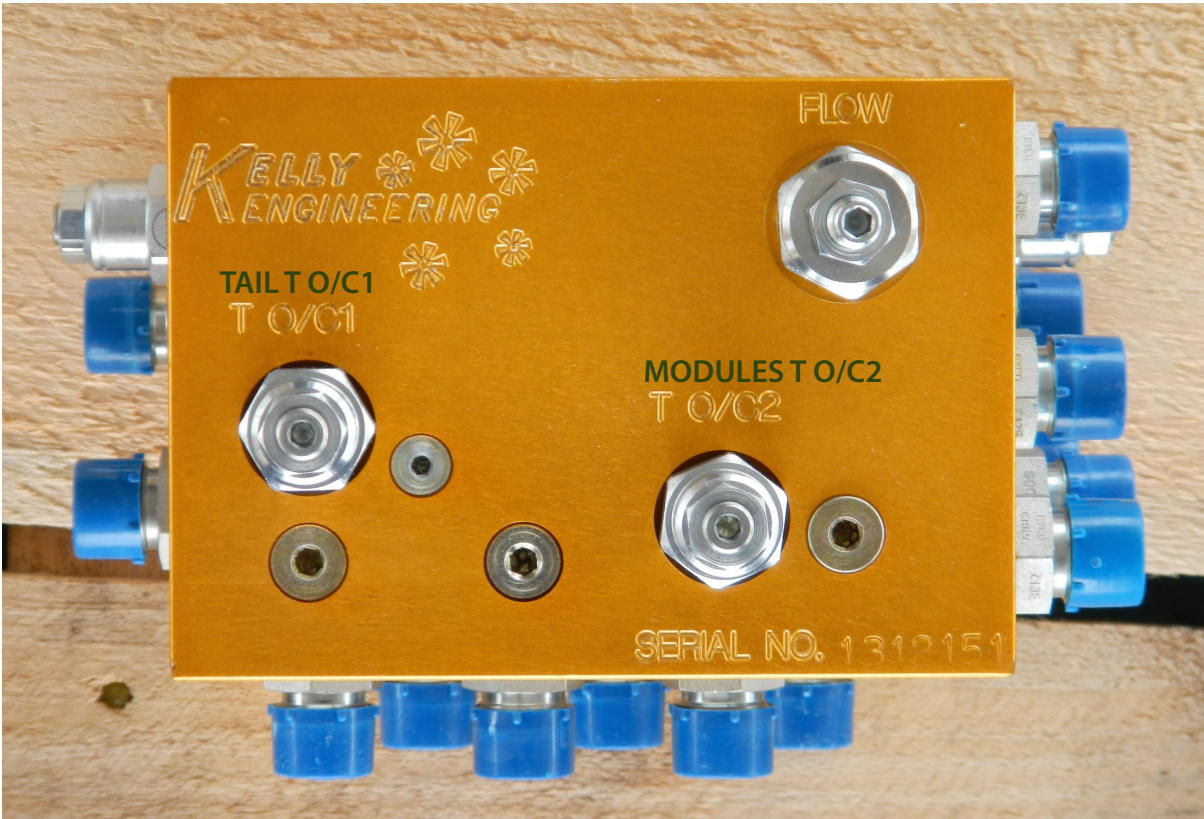

# Hydraulic sequence valves

## Trouble shooting

<b>Problem with:</b>	<b>Symptom</b>	<b>Page</b>	
<b>Unfolding</b>	Right wing won't rise from folded position	39	
	Right wing rises but left wing won't rise	40	
	Center cylinders extend before outer wings are both straight (vertical)	40	
	Both wings stand vertical then stop	41	
	No movement at all	41	
	Sequence was working but becomes erratic	41	
	<b>Folding</b>	No movement at all	42
Both main wings stand vertical then left wing wont fold.		42	
Left hand outer wing folds before both inner wings are vertical		43	
Right hand outer wing folds before both inner wings are vertical		43	
Main wings fold, left outer wing folds the right outer wing stands vertical		44	
Outer wings collide when folding		44	
Left outer wing stands vertical and right outer wing folds over		45	
Sequence was working but becomes erratic		45	
<b>Working</b>		Wings sag in middle when working	46
<b>Unresolved</b>		Contact service agent or manufacturer	46

## Dual Function

Manifolds from version 8, 9 and 10 have the ability to allow independent raising and lowering of the tail section. This means that when crossing roadways or waterways the front and rear can be quickly raised to lift the chains clear of the ground. This allows you to back into corners of fields and improves turning on end rows. The new functionality requires 3 pairs of tractor remotes to operate. It will be possible to operate the machine successfully on a tractor with only two circuits after some minor alterations to hose connections and routing.

## Unfolding

During unfolding the following sequence must be observed.

1. Lower front tongue assembly to working height
2. Unfold wings fully until main cylinder pins centre in their slots
3. Lower tail and modules fully.

# Hydraulic sequence valves

## Trouble shooting

When unfolding the wings, oil travels directly to the right hand outer wing cylinders until they are fully extended. Oil then opens S3 and flows to the left hand outer wing cylinders. When these are fully extended, oil pressure opens S4 and flows to the center cylinders pushing the extended wings to the ground. There is an over/center valve, L1, that protects the main wings from falling and controls their descent.

### RIGHT WING WON'T RISE FROM FOLDED POSITION

If the pressure required to raise the right wing is greater than tractor pressure then oil will not flow. This may occur if chain is full of mud or other matter increasing the weight of the chain. It may also occur on tractors with lower than original hydraulic oil pressure.

If the pressure setting of S3 is too low it can open before lifting the top wing. Oil will then try to raise the second wing, which is trapped and can not move. The main cylinders will try to force the wings apart.

Disc chain may be caught on one of the saddles or supports, especially on the tail, preventing the wing from lifting. Usually you will see the top wing raise a little then stop if this is the case.

Oil may bypass a cylinder piston seal if the seal or piston has failed. You will hear oil flowing in one cylinder and that cylinder should warm up compared to the remaining cylinders.

Check-valves C4 or C5 may be held open by contamination allowing oil to flow to left wing or main cylinders.

### Solution

Clean chains of mud and debris.

Check the disc chain for areas it might be caught and make adjustments to support brackets or folding procedure.

Increase the pressure setting on S3 by 1/2 turn clockwise (repeat if required).

Remove check-valve C4 or C5 and inspect.

If oil is flowing through the manifold but no movement is occurring, then it is possible that a piston seal has failed. Sequentially isolate cylinders until culprit is identified (Fold wings to transport position before removing cylinders, DEATH or INJURY could result).

Check that tractor hydraulic oil pressure is adequate (2200psi / 151Bar).

# Hydraulic sequence valves

## Trouble shooting

### RIGHT WING RISES BUT LEFT WING WON'T RISE

If the pressure required to raise the left wing is greater than tractor pressure then oil will not flow. This may occur if chain is full of mud or other matter increasing the weight of the chain. It may also occur on tractors with lower than original hydraulic oil pressure. Left wing is longer than right wing and may require more pressure to lift.

If the pressure setting of S3 is too high then oil will stall and left wing will not raise.

Disc chain may be caught on one of the saddles or supports, especially on the rear "M" bracket mounts, preventing the wing from lifting.

Oil may bypass a cylinder piston seal if the seal or piston has failed. You will hear oil flowing in one cylinder and that cylinder should warm up compared to the remaining cylinders.

A check-valve may be stuck open allowing oil to bypass.

#### Solution

- Clean chains of mud and debris.

- Check the disc chain for areas it might be caught and make adjustments to support brackets or folding procedure.

- Decrease the pressure setting on S3 by 1/2 turn clockwise (repeat if required).

- Remove and inspect check-valve C4. Clear any contamination and reinstall.

- If oil is flowing through the manifold but no movement is occurring, then it is possible that a piston seal has failed. Sequentially isolate cylinders until culprit is identified (Fold wings to transport position before removing cylinders, DEATH or INJURY could result).

- Check that tractor hydraulic oil pressure is adequate (2200psi / 151Bar).

### CENTER CYLINDERS EXTEND BEFORE OUTER WINGS ARE BOTH STRAIGHT (VERTICAL)

If the pressure required to raise the right wing is greater than that set by S3 then oil will flow past S3 to the left wing. As the right wing rests on top of the left wing and neither can move then oil is also forced past S4 to the main wing cylinders causing them to extend while the outer wings are still folded. As the main wings unfold and the weight is transferred from the outer wings then the oil will flow to the outer wing cylinders allowing the wings to straighten. Do not allow this to continue as the cylinder pins will shear and the wings will fall uncontrolled.

The same symptom will occur if check valve C4 is held open by contamination.

As above, mud or debris in the chain will change the load and operating pressure required to lift the outer wings.

#### Solution

- If chains are clean then increase the pressure setting on S3 (right wing will raise).

- Increase pressure setting on S4 (left wing will raise).

- Remove and inspect check-valve C4. Clear any foreign material from around ball & seat area.



# Hydraulic sequence valves

## Trouble shooting

### **BOTH WINGS STAND VERTICAL THEN STOP**

Once the outer wings have stood vertical oil pressure opens S4 and allows flow to the main wing cylinders. An over/center valve, L1 prevents the wings from falling and controls their descent to working position.

#### **Solution**

Lower pressure setting on S4, screw center counter clockwise 1/2 turn, check, repeat if needed.  
L1 over/center valve may be set too high, preventing return oil flowing to tank. Reduce pressure setting on L1 by turning CLOCKWISE 1 turn.  
Check that hydraulic flow on the tractor is not set to very low or off.  
Check tractor hydraulic pressure (should exceed 2200 psi -151 Bar).  
Call service technician. Test for oil flow. If flow is present isolate cylinders one at a time to ensure integrity of cylinder piston seal (Fold wings to transport position before removing cylinders, DEATH or INJURY could result).

### **NO MOVEMENT AT ALL**

#### **Solution**

See first point. Check and if necessary clean chains of mud or debris.  
Check that hose tips are correctly engaged in tractor breakaway sockets.  
Check that any taps or electronic transport locks are open on the tractor.  
Check that hydraulic flow on the tractor is not set to very low or off.  
Check tractor hydraulic pressure (should exceed 2200 psi -151 Bar).  
Call service technician. Test for oil flow. If flow is present isolate cylinders one at a time to ensure integrity of cylinder piston seal.

### **SEQUENCE WAS WORKING BUT HAS BECOME ERRATIC**

The sequence valve manifold has an oil flow capacity of 8 gallons (US) per minute (30Lpm). At this flow the sequence cartridges are able to cope with the flow of oil and operate at their correct settings. If the flow rate is set too high, pressure in the manifold builds up and may unseat the sequence valves prematurely or in an unpredictable manner.

#### **Solution**

Set tractor hydraulic remote oil flows to slow (20%).  
Engage tractor hydraulic lever slowly.  
Reduce flow by screwing flow control valve E counterclockwise 2 turns.

# Hydraulic sequence valves

## Trouble shooting

### Folding

The fold sequence is as follows:

1. Raise tail and modules
2. Raise wings until fully folded
3. Raise tongue assembly to transport height.

During folding, oil travels directly to the main wing cylinders. When these are all closed oil then opens S1 allowing oil to flow to the left outer wing cylinders. When these cylinders close oil pressure opens S2 to fold the right outer wing.

### NO MOVEMENT AT ALL

The main cylinders are the first to receive oil from tractor and should lift the wings. Failure to operate as expected could indicate excess mud in the discs. If the tail has not been raised it is possible that the wings will not lift up as the chain tension prevents them from rising.

#### Solution

- Clean mud from the discs.
- Raise the tail section fully prior to folding the wings.

### BOTH MAIN WINGS STAND VERTICAL THEN LEFT WING WON'T FOLD

Oil flows straight from tractor to the main cylinders. Once raised oil must then force S1 open to allow flow to the left outer wing. If S1 is set too high then oil flow will stall and the left outer wing will not fold.

Over/center valve L4 is used to hold the left wing straight during operation. If L4 is set at too high a pressure the left wing will not fold. L4 is a pilot operated valve and requires correct system pressure to function.

#### Solution

- Reduce the pressure setting on S1 by screwing counter clockwise 1/2 turn (repeat as required).
- Reduce pressure setting on L4 by screwing counter-clockwise 1 turn.

# Hydraulic sequence valves

## Trouble shooting

### LEFT HAND OUTER WING FOLDS BEFORE BOTH INNER WINGS ARE VERTICAL

If the pressure required to raise the wings to vertical is greater than the pressure setting on S1 then oil will pass S1 and cause the left hand outer wing cylinders to retract. This may occur if there is excessive load such as mud or debris or on occasions where the chains may have become blocked and buried.

The same symptom can be seen if check-valve C3 is held open by contamination.

#### Solution

Check and clean if necessary any mud or debris from chains. Do not attempt to fold the machine if the chains are buried during a blockage. Clear away the soil from the chains first.

If the chains are clean but problem persists it may be necessary to adjust S1. Increase the pressure setting by screwing clockwise 1/2 turn.

Remove and clean C3 check-valve.

### RIGHT HAND OUTER WING FOLDS BEFORE BOTH INNER WINGS ARE VERTICAL

In the normal folding process the left wing must fold before the right wing. Even if both S1 and S2 have pressure settings that are too low, then both wings will move together. For the right outer wing to move first then check-valve C1 must be open.

#### Solution

Remove and clean C1 check-valve.

# Hydraulic sequence valves

## Trouble shooting

### MAIN WINGS FOLD, LEFT OUTER WING FOLDS THEN RIGHT OUTER WING STANDS VERTICAL

Oil is forced to the left outer wing cylinders which cause the left wing to fold down. Once these cylinders are closed oil pressure increases and opens S2 allowing oil to flow to the right hand outer wing cylinders. If S2 is set too high the oil flow can stall after left outer wing is folded.

Over/center valve L3 is used to hold the right wing straight during operation. If pressure setting on L3 is too high the left wing will not fold. L3 is a pilot operated valve and requires correct system pressure to function.

#### Solution

- Reduce the pressure setting on S2 by screwing counter clockwise 1/2 turn (repeat as required).
- Reduce pressure setting on L3 by screwing counter-clockwise 1 turn.

### OUTER WINGS COLLIDE WHEN FOLDING

If you witness the two outer wings coming together when folding you must immediately stop and reverse the operation. Unfold the wings to vertical then recommence slowly. The individual wings should fold in sequence. If they both continue to fold together then oil must be passing S2 prematurely. For this to happen S2 has pressure set too low.

#### Solution

- Increase the pressure setting on S2 by screwing clockwise 1/2 turn (repeat as required).

# Hydraulic sequence valves

## Trouble shooting

### LEFT OUTER WING STANDS VERTICAL AND RIGHT OUTER WING FOLDS OVER

The main wings stand vertical then the left wing does not move but the right hand outer wing folds over then all movement stops. This can occur when the L4 over/center valve that holds the wing straight during operation in the field, will not release and allow the wing to fold. L4 could be contaminated but would usually stick open. L4 could have failed but this is rare.

#### Solution

Decrease the pressure setting on L4 by screwing it counter-clockwise 1/2 turn.

### SEQUENCE WAS WORKING FINE BUT HAS BECOME ERRATIC

The sequence valve manifold has an oil flow capacity of 8 gallons (US) per minute (30Lpm). At this flow the sequence cartridges are able to cope with the flow of oil and operate at their correct settings. If the flow rate is set too high, pressure in the manifold builds up and may unseat the sequence valves prematurely or in an unpredictable manner.

Occasionally foreign material may lodge in one of the check-valves. This will allow oil to flow in a seemingly illogical manner. Symptoms suggest valve adjustments however the logical adjustments have no effect.

#### Solution

Set tractor hydraulic remote oil flows to slow (20%).

Engage tractor hydraulic lever slowly.

Reduce flow by screwing flow control valve R counter clockwise 2 turns.

### NO MOVEMENT AT ALL

#### Solution

Check that hose tips are correctly engaged in tractor breakaway sockets.

Check that any shut off valves or electronic transport locks are open on the tractor.

Check that hydraulic flow on the tractor is not set to very low or off.

Check tractor hydraulic pressure (should exceed 2200psi - 151 Bar).

Call service technician. Test for oil flow. If flow is present isolate cylinders one at a time to ensure integrity of cylinder piston seal.

# Hydraulic sequence valves

## Trouble shooting

### Working

#### Wings “sag” in middle while working

Both sets of wings are locked straight in working position by the L4 and L3 over/center valves. If the pressure setting on these valves is too low the wings may not be effectively locked.

#### Solution

Left wing sagging, increase the pressure setting on L4 by screwing it COUNTER CLOCKWISE 1/2 turn.

Right wing sagging, increase the pressure setting on L3 by screwing it COUNTER CLOCKWISE 1/2 turn.

## Contact details

### IF THESE ADJUSTMENTS DO NOT SOLVE THE PROBLEM

Contact your service agent for assistance. There may be a fault with one of the cartridges. The valve manifolds are tested at factory and again prior to shipping. The assembling agent will also have ensured the correct operation prior to delivery. Very rarely, but occasionally valves do fail. The usual cause is ingress of contaminant.

You may also contact Kelly Engineering for technical advice and assistance.

International : 011 618 8667 2253

USA: 608-527-2386

Canada: 306-213-6675

From within Australia: 08 8667 2253

# Notes

